

INSTRUCTIONS FOR USE

A-dec® EA-51LT Electric Motor



A-DEC[®] EA-51LT ELECTRIC MOTOR

Instructions For Use

Copyright

©2006 by A-dec Inc. All Rights Reserved.

2601 Crestview Drive, Newberg, OR 97132, USA

Printed in USA.

A-dec Inc. makes no warranty of any kind with regard to this material, including, but not limited to, the implied warranties of merchantability and fitness for a particular purpose. A-dec Inc. shall not be held liable for any errors contained herein or any consequential or other damages concerning the furnishing, performance or use of this material. The information in this document is subject to change without notice. If you find any problems in the documentation, please report them to us in writing. A-dec Inc. does not warrant that this document is error free.

No part of this document may be copied, reproduced, altered or transmitted in any form or by any means, electronic or mechanical, including photocopying, recording or by any information storage and retrieval system, without prior written permission from A-dec Inc.

Publication Number: 86.0616.00

Revision Date: Rev B 2007-12

Trademarks

A-dec logo, A-dec 500, Cascade, Cascade Master Series, Century Plus, Continental Decade, Performer, Preference, Preference Collection, and Radius are registered trademarks in the U.S. Patent and Trademarks office.

A-dec, and ICX are also trademarks of A-dec Inc.

Comments and Feedback

Thank you for taking the time to use the *A-dec EA51-LT Electric Motor Instructions for Use*. We would appreciate any feedback or comments you have about this document. Please mail, email, or phone us with your comments. You can reach us at:

A-dec Inc.

Technical Communications Department

2601 Crestview Drive

Newberg, OR 97132

Reach us by phone at: 1.800.547.1883

email: techcomm@a-dec.com

website: www.a-dec.com

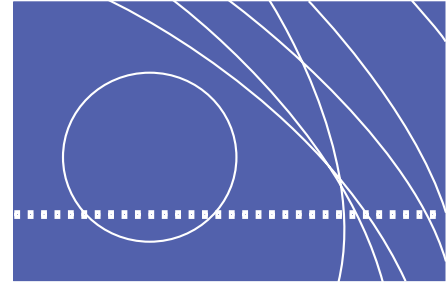

CONTENTS

Introduction	1
A-dec EA-51LT Electric Motor Features	1
Operating Instructions	2
Safety Notes Before You Begin.....	2
Assembly	3
Program and Use.....	3
Maintenance.....	9
Disinfect and Sterilize	9
Replace the O-rings	10
Remove and Replace the Bulb	11











List of Figures

Figure 1 A-dec EA-51LT Electric Motor	1
Figure 2 Align Motor Connection Tubes and Tubing Connection Openings	3
Figure 3 Operator Status.....	4
Figure 4 Program Handpiece Standard Mode Settings	5
Figure 5 Forward/Reverse Button.....	5
Figure 6 Endodontics Mode Touchpad Screen	6
Figure 7 Change the O-ring on the Motor Tubing Terminal.....	10
Figure 8 Replace O-rings on the Motor	10
Figure 9 Replace Motor Bulb.....	11

List of Tables

Table 1 Symbols	iv
Table 2 Classification of Equipment	iv
Table 3 Environmental Specifications	iv
Table 4 Electric Motor, Air and Water Coolant Presets (Standard Mode)	4
Table 5 Endodontics Mode Settings	7

Identification of Symbols

Symbol	Description
	Recognized by Underwriters Laboratories Inc. with respect to electric shock, fire and mechanical hazards only in accordance with UL 60601-1 (2601-1) and under mutual recognition agreement with CAN/CSA C22.2, No. 601.1.
	Classified by Underwriters Laboratories Inc. with respect to electric shock, fire and mechanical hazards only in accordance with UL 60601-1 (2601-1) and under mutual recognition agreement with CAN/CSA C22.2, No. 601.1.
	UL listed to UL 61010A-1, BS EN 61010-2-010 and Canadian (CAN/CSA C22.2, No. 1010.1-92) safety standards.
	Conforms to applicable European Directives (refer to Declaration of Conformity).
	Protective earth (ground).
	Functional earth (ground).
	Attention, consult accompanying documents. No user serviceable parts. Attention, line voltage. Only licensed electrician should remove cover.
	Type B applied part.
	Class II equipment.
	Caution: Metal surfaces can be hot during and following the dry cycle.

Classification of Equipment (EN-60601-1)

Type/Mode	Classification
Types of shock protection	CLASS I EQUIPMENT: Dental chairs, dental lights, and power supplies CLASS II EQUIPMENT: Chair, wall, and cart-mounted delivery systems
Degree of shock protection	TYPE B APPLIED PART: Delivery systems only
Degree of protection against water ingress	ORDINARY EQUIPMENT: All products
Mode of operation	CONTINUOUS OPERATION: All models except dental chairs CONTINUOUS OPERATION WITH INTERMITTENT LOADING: Dental chairs - 5% duty cycle
Flammable Gasses:	Not suitable for use in the presence of a flammable anesthetic mixture with air, oxygen, or nitrous oxide, where such gasses may accumulate in concentration (closed space).

Electrical Rating

Type	Specification
Volts:	100/110-120/220-240 VAC
Frequency:	50-60 Hz
Current:	As configured and specified in equipment manual (products labeled 15A or greater require dedicated circuit, identified in distribution panel).

Environmental Specifications

Temperature/Humidity	Specification
Storage/Transportation	Temperature: -40°C to 70°C (-40°F to 158°F) Relative humidity: 80% for up to 31°C, decreasing linearly to 50% at 40°C
Operating	Temperature: 10°C to 40°C (40°F to 104°F) Relative humidity: 80% for up to 31°C, decreasing linearly to 50% at 40°C.
Indoor Use:	Altitude up to 2,000M (6,563 ft.), installation category II, pollution degree 2. (UL 61010A-1 and CAN/CSA C22.2, No. 1010.1-92 only)

Warranty

A-dec warrants all products against defects in materials or workmanship for one year from time of delivery. A-dec's sole obligation under the warranty is to provide parts for the repair, or at its option, to provide the replacement product (excluding labor). The buyer shall have no other remedy. All special, incidental, and coincidental damages are excluded.

Written notice of breach of warranty must be given to A-dec within the warranty period. The warranty does not cover damage resulting from improper installation or maintenance, accident or misuse. The warranty does not cover damage resulting from the use of cleaning, disinfecting or sterilization chemicals and processes. The warranty also does not cover light bulbs. Failure to follow instructions provided in the *A-dec Instructions For Use* (operation and maintenance instructions) may void the warranty.

A-dec warrants A-dec dental chair cylinders, both lift and tilt for ten years from the date of purchase of the chair or the cylinder. This warranty is retroactive to A-dec chair cylinders already in the field. The warranty covers chair cylinders A-dec finds to have manufacturing irregularities. Stool cylinders are covered under A-dec's one-year warranty.

No other warranties as to merchantability or otherwise are made. For service information, contact your local authorized A-dec dealer. Check with local codes and ADA (Americans with Disabilities Act) requirements for installation of this product.



CAUTION Federal law restricts this device to sale by or on the order of a dentist, physician, or any other practitioner licensed by the law of the state in which he or she practices to use or order the use of this device.

Equipment Alterations Policy

Certain modifications or alterations of A-dec equipment which expand the use of A-dec equipment beyond its design and intent, or which override any safety features of A-dec equipment may jeopardize doctor, patient or staff safety. Field modifications that alter the electrical and/or mechanical safety of A-dec dental devices are in conflict with Underwriters Laboratory (UL) construction file requirements and are not sanctioned by A-dec. Examples of field modifications that diminish safety design include, but are not limited to: rendering access to the line voltage without the use of tools, modification of supporting elements that increase or shift loading characteristics, and the addition of any powered device that exceeds the design limits of the dental system. The use of accessory equipment not complying with the equivalent safety requirements of A-dec equipment may lead to a reduced level of safety of the resulting

system. It is the responsibility of the equipment distributor and the installer to assure that the installation complies with all building code requirements. The responsibility to determine whether a modification or alteration of A-dec equipment falls within these constraints is with the person(s) who initiates, approves and/or performs such modification or alteration. A-dec will not respond to inquiries on an individual basis. This person(s) will be deemed to have assumed all associated risks with such alteration or modification and will hold A-dec harmless from resulting claims, including product liability claims. Additionally, such modification or alteration voids A-dec's warranty and may invalidate UL or other regulatory agency approval.

About This Document

Welcome to the *A-dec EA51-LT Electric Motor Instructions for Use*. This guide provides an easy-to-use source of technical information for operating and maintaining your A-dec EA-51LT Electric Motor.

Before using the EA-51LT Electric Motor, make note of all cautions and warnings. Read the component descriptions, and become familiar with the locations of features and controls.

This document contains the following information:

- Feature descriptions
- Operation
- Adjustments
- Maintenance tasks

Intended Audience

This guide is intended for doctors and dental staff.

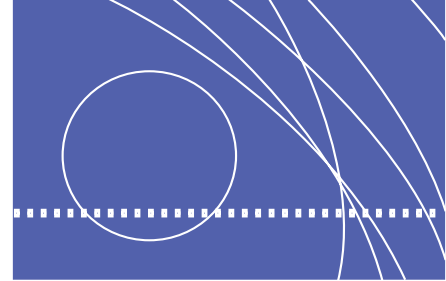

INTRODUCTION

This guide contains information about:

- Features of the A-dec EA-51LT electric motor
- Operating instructions
- Maintenance

A-dec EA-51LT Electric Motor Features

The A-dec EA-51LT Electric Motor features:

- Programmable speed and torque settings for ease of use and safety
- Auto-sensing with auto-forward, auto-stop and auto-reverse
- Up to 8 memory presets per handpiece position
- Separate A and B presets for two different operators
- Single-button push between endodontics and standard modes for efficiency

Figure 1 A-dec EA-51LT Electric Motor



Operating Instructions

This section describes how to operate the A-dec EA-51LT Electric Motor:

- Safety Notes Before You Begin
- Assembly
- Program and Use

Safety Notes Before You Begin

Before you use the A-dec EA-51LT Electric Motor, note:

- Always ensure the correct operating conditions.
- Always ensure the correct supply voltage.
- Check the motor for damage and loose parts before and between uses.
- Check that air and water coolant spray are set correctly.
- The operation of the motor is not suitable in an explosive gaseous atmosphere.
- Interference may occur when used on patients with cardiac pacemakers.
- Always follow recommendations made by the manufacturer of the transmission instrument and the rotary instrument.
- The operation of this motor is permitted only on dental units which correspond to the standards IEC 601-1 (EN 60601-1) and IEC 601-1-2 (EN 60601-1-2) or as labeled (UL 2601-1).
- Electrical safety is inherent in equipment grounding and insulation
- Operating mode: With the light enabled, the dental motors are designed for intermittent operation of 2 minutes ON and 3 minutes OFF.
- Sterilize the motor in a water steam sterilizer with vacuum for 10 minutes at 134 °C (273 °F).



CAUTION Federal law restricts this device to sale by or on the order of a dentist, physician or any other practitioner licensed by the law of the State in which he or she practices to use or order the use of the device.

The dental motor should be maintained according to the manufacturer's recommendations and in line with infection control procedures for the safety and well-being of patients.

Improper use, e.g. missing hygienic maintenance, or non-compliance with our instructions of the use of accessories and spare parts which are not approved by A-dec, invalidates all claims under warranty and any other claims.

Assembly

The EA-51 LT motor and handpiece easily assemble. To assemble:

Install the Motor on the Handpiece Tubing

1. Align the motor connection tubes with the connection openings on the handpiece tubing.
2. Press the motor and the tubing together until you hear two clicks.



NOTE If the motor fails to connect, remove it from the tubing. Push the tubing nut back to the stop, then repeat Steps 1 and 2.

Figure 2 Align Motor Connection Tubes and Tubing Connection Openings

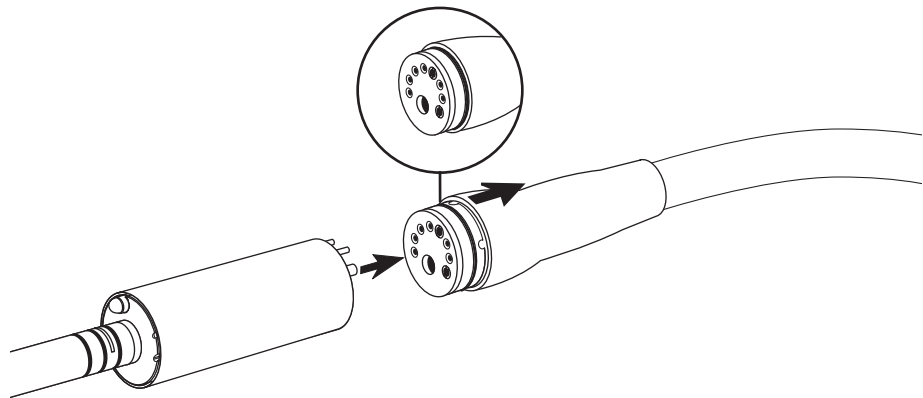

3. Check that the motor has engaged the tubing securely. The motor and tubing should not separate with a gentle pull.

Install the Handpiece on the Motor



CAUTION To avoid injury, do not connect or remove the handpiece while the motor is running.

1. Push the handpiece onto the motor. If the handpiece is fiber optic, be sure to correctly align the notch.
2. Check for a secure hold on the motor. The handpiece should not come off with a gentle pull.

Program and Use

Fully integrated into the A-dec Deluxe touchpad, the EA-51LT allows you to easily program settings to switch electric handpiece use from standard to endodontics mode. This section describes how to customize your touchpad settings.

Standard Mode

Activate the electric motor by withdrawing the handpiece from the holder. The settings that appear are the ones last used for that handpiece position.

The electric handpiece allows you to choose a precise pre-set speed or to “feather” up to that speed. Table 4 lists the factory presets for electric handpieces:

Table 4 Electric Motor, Air and Water Coolant Presets (Standard Mode)

Memory Button	Preset Speed	Air Coolant	Water Coolant
M1	2,000 RPM	On	On
M2	10,000 RPM	On	On
M3	20,000 RPM	On	On
M4	40,000 RPM	On	On

Program the A-dec Touchpad in Standard Mode. The A-dec Deluxe touchpad allows you to program four memory buttons with your specific RPM setting. The total range is 300-40,000 RPM. Each button can retain one setting per handpiece per operator A/B, so that a total of 16 customized settings per handpiece is possible (8 in standard mode plus 8 in endodontic mode). To specify a setting for an operator, toggle the A/B operator button before changing a setting. The display screen indicates the operator status (see Figure 3).

Figure 3 Operator Status

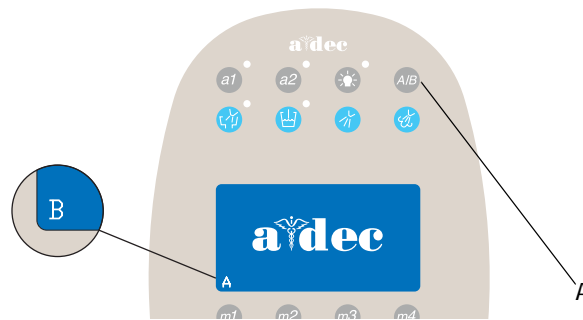

(A) A/B Operator Toggle Button

To change your handpiece setting:

1. Press the minus (-) and plus (+) buttons to adjust the RPM. The RPM values appear in the display screen (see Figure 4).
2. If desired, use the toggle buttons on the touchpad to change air and water settings.
3. To place the setting into memory (optional), press the Program button, then press the memory button you want to set. Three beeps confirm the setting.

Figure 4 Program Handpiece Standard Mode Settings

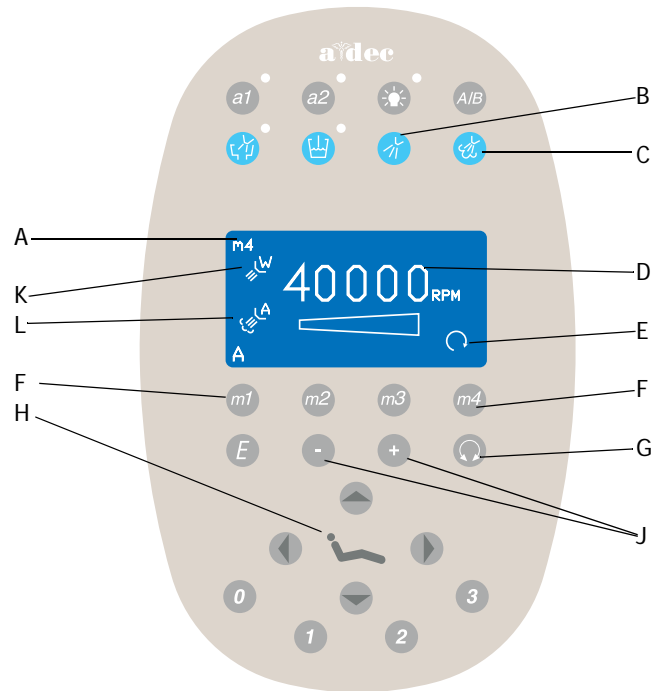

(A) Memory Setting Indicator; (B) Water Coolant Button; (C) Air Coolant Button; (D) Speed Limit Setting; (E) Forward/Reverse Indicator; (F) Memory Button; (G) Forward/Reverse Toggle Button; (H) Program Button; (J) Use - and + Buttons to Adjust Speed; (K) Water Coolant Indicator; (L) Air Coolant Indicator

Forward/Reverse Button. The forward/reverse toggle button changes the handpiece direction. The system defaults to the forward position when you return the handpiece to the holder or turn off the system (see Figure 5). In reverse mode, the screen icon flashes continuously.



NOTE You can also use the foot control as a forward/reverse toggle. When the motor has stopped, tap the accessory (chip/air) button to change the direction.

Figure 5 Forward/Reverse Button



(A) Forward/Reverse Indicator; (B) Forward/Reverse Toggle Button

Endodontics Mode

In addition to handpiece speed adjustments, the endodontics mode allows you to change a number of settings based on the specific file and desired handpiece behavior. Icons in the touchpad window reflect the settings (see Figure 6).



NOTE For more information regarding speed limit and torque limit for a specific file, consult the file manufacturer.

Figure 6 Endodontics Mode Touchpad Screen

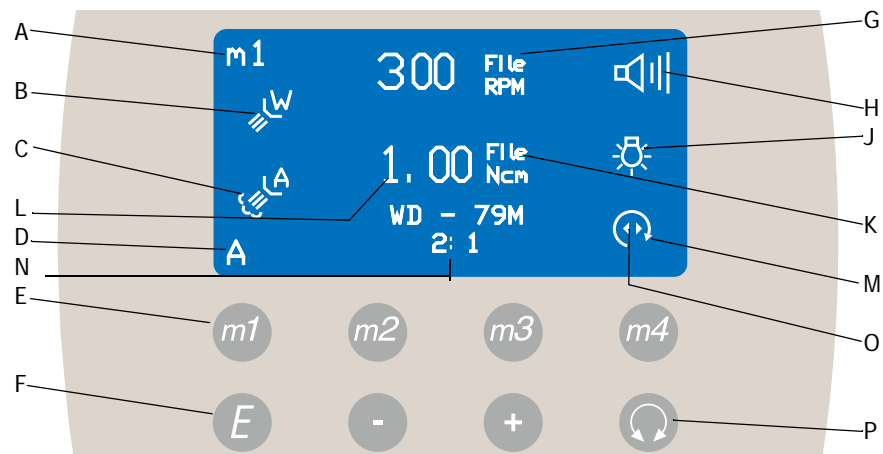











(A) Memory Setting Indicator; (B) Water Coolant Indicator; (C) Air Coolant Indicator; (D) Operator Mode Indicator; (E) Memory Button; (F) Endodontics Mode Toggle Button; (G) File Speed Limit; (H) Warning Beep Indicator; (J) Endodontics Light Indicator; (K) File Torque Unit Indicator; (L) File Torque Limit; (M) Forward/Reverse Indicator; (N) Handpiece Ratio Setting; (O) Torque Mode Indicator; (P) Forward/Reverse Toggle Button

Program the A-dec Touchpad in Endodontics Mode. To change a setting:

1. Withdraw the handpiece from the holder.
2. If the touchpad window is not in endodontics mode, press the endodontics mode toggle button (see Figure 6). The endodontics screen appears.
3. Use the + or - button to activate the endodontics change mode. A white reverse video box appears.
4. Use the chair positioning buttons to move from setting to setting in the touchpad window.
5. Use the + and - buttons to change the setting as desired.
6. To place the speed limit, torque limit and ratio into memory (optional), press the Program button, then the memory button you want to set. Three beeps confirm the setting.

Table 5 lists and defines the touchpad window icons for Endodontics mode:

Table 5 Endodontics Mode Settings

Icon	Setting	Description
	Speed	Setpoint for file speed limit. For more information, consult your file manufacturer.
	Torque	Setpoint for file torque limit. For more information, consult your file manufacturer.
	Torque Units	Toggles between Ncm (Newton centimeters) and gcm (Gram centimeters). Adjusting this setting for one handpiece changes it for all handpiece settings. Note: 1 Ncm=102 gcm
	Ratio	Sets the handpiece ratio. For more information, consult your handpiece manufacturer.
	Air Coolant	On/Off—when active, supplies air coolant to the handpiece.
	Water Coolant	On/Off—when active, supplies water coolant to the handpiece.
	Light Source	Enables/Disables endodontics handpiece light source.
	Torque Mode	Adjusting this setting for one handpiece changes it for all handpiece settings. This icon appears with the forward/reverse indicator. <ul style="list-style-type: none"> • Auto-off—the motor shuts off when the file speed reaches the torque limit. • Auto-reverse—the motor stops and reverses direction when the file reaches the torque limit. • Auto-forward—when the file reaches the torque limit, the motor stops, reverses 3 turns, then changes back to forward again. Note: If the file is stuck, this cycle repeats three times before the motor stops.
	Auto reverse	
	Auto forward	
	Beeper	On/Off—when active, warning beep sounds when you approach torque limit and double beeps when the file auto-reverses. Adjusting this setting for one handpiece changes it for all handpiece positions.



NOTE The A-dec | W&H WD-79M endodontics attachment has a special feature due to its ball-bearing design. Its life-long efficiency factor is stable and known, therefore the A-dec endodontics system is able to control and display file torque very accurately. All other handpieces have unknown life-long efficiency factors and therefore stated torque values are approximate.

Other System Adjustments

Additional system choices are available. Consult your dealer to globally change to any of these setting options:

- Auto-Off Delay – The amount of time the handpiece remains lit when idle. The default is 5 seconds. Stepping on the foot control refreshes the delay and the lamp relights. The light stays on as long as you depress the foot control.
- Light Source Auto-On/-Off – When active, the handpiece light automatically turns on when you lift the handpiece from the holder. Default in standard mode is On; in endodontics mode is Off.
- Voltage – Depending on your brightness preference and the bulb manufacturer's usage guidelines, the voltage setting adjustment for each handpiece light source.

Maintenance

This section contains information to:

- Disinfect and Sterilize
- Replace the O-rings
- Remove and Replace the Bulb

Disinfect and Sterilize



NOTE The electric motor should be maintained according to the manufacturer's recommendations and in line with infection control procedures for the safety and well-being of patients.

Improper use, e.g. missing hygienic maintenance, or non-compliance with our instructions or the use of accessories and service parts which are not approved by A-dec, invalidates all claims under warranty and any other claims.

Clean and Disinfect the Motor

To clean and disinfect the motor:

1. Wear protective gloves.
2. Disconnect the handpiece and the motor by pulling the two apart.
3. Carefully wipe the exterior of the motor with a soft cloth. Use only commercially available surface disinfectants or ethyl alcohol.
4. Dry the motor completely.

Sterilize the Motor

To sterilize the Motor:

1. Purge the water lines with air.
2. Remove the motor from the tubing by pushing the tubing sheath back up to the stop while pulling the motor off the handpiece tubing.
3. Place the motor in sterile pouch (FDA market cleared), equivalent to sterile goods packaging DIN 58953.
4. Sterilize the motor in a water steam sterilizer with vacuum for 10 minutes at 134 °C (273 °F).
5. Be sure the motor is dry before removing from the sterilizer.

Replace the O-rings

Replace the O-ring on the Motor Tubing Terminal

To change the O-ring on the motor tubing terminal (see Figure 7):

1. Squeeze the O-ring firmly between thumb and forefinger to form a loop.
2. Slide the O-ring up and off the tubing terminal.
3. Slide the new O-ring on carefully.

Figure 7 Change the O-Ring on the Motor Tubing Terminal

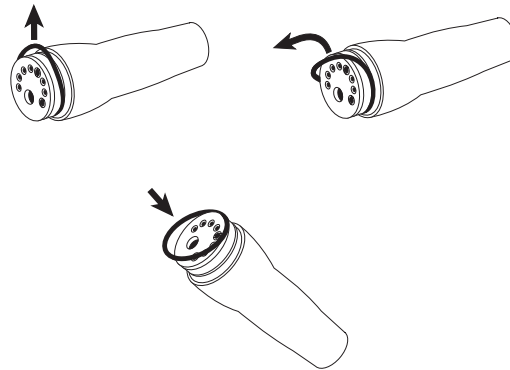

Replace the O-rings on the Motor

A-dec recommends you replace all O-rings on the motor at the same time. To replace the O-rings on the motor (see Figure 8).

1. Squeeze an O-ring firmly between thumb and forefinger to form a loop.
2. Slide the O-ring up and off the motor.
3. Slide a new O-ring on carefully and position in the groove.

Figure 8 Replace O-Rings on the Motor

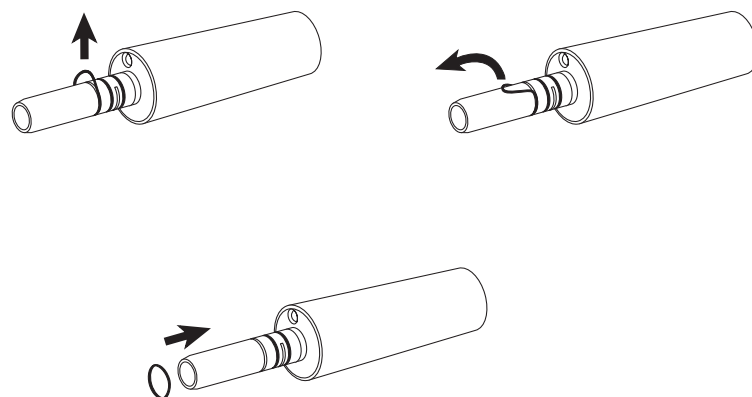

Remove and Replace the Bulb

Remove a Bulb from the Motor

To remove a bulb from the motor:



CAUTION Remove the motor from the handpiece tubing to change the bulb.

1. Remove the motor sheath by sliding off in the direction indicated (see Figure 9).
2. Position the pliers between the bulb and the bulb holder.
3. Slide out the bulb carefully.

Figure 9 Replace Motor Bulb

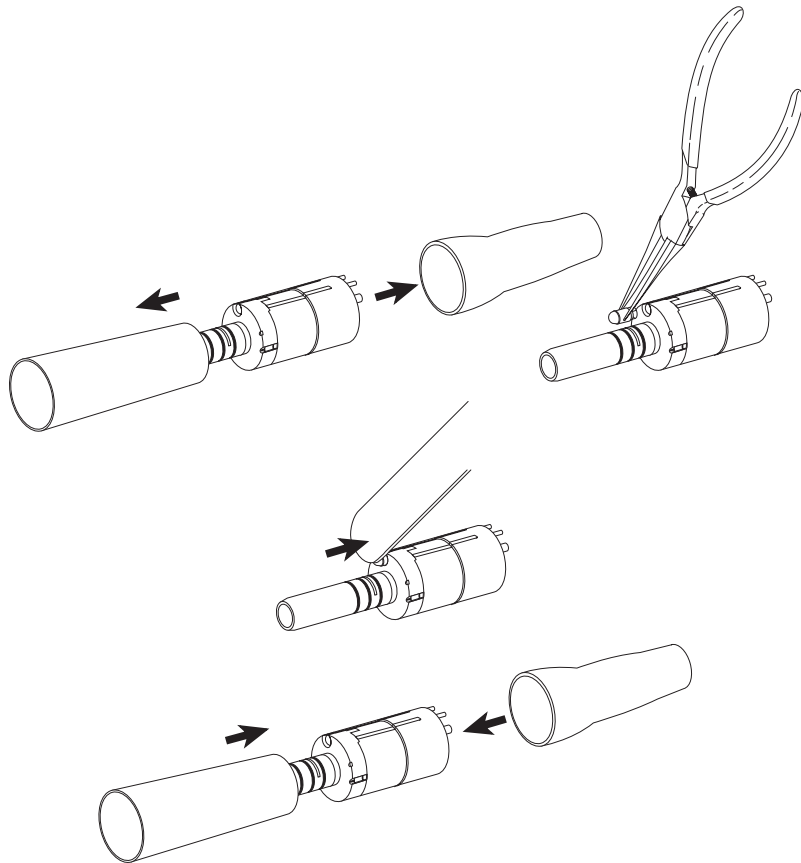

Install a Bulb in the Motor

To install a bulb in the motor:

1. Hold the new bulb firmly in the pliers with the flat side facing the motor and the dot facing out.
2. Insert the bulb into the bulb holder and push into place with the pliers handle.
3. Replace the motor sheath.

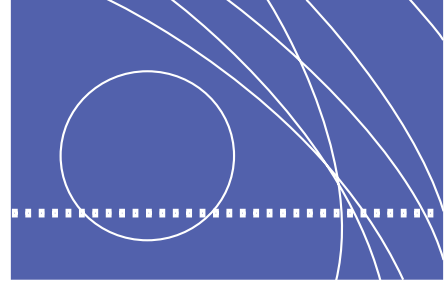

INDEX

A

- assembly
 - install handpiece on motor, 3
 - install motor on handpiece tubing, 3

B

- bulb replacement, 11

C

- changing settings
 - endodontics mode, 6
 - standrd mode, 5
- cleaning motor, 9

D

- disinfecting motor, 9

E

- EA-51LT Electric Motor
 - bulb removal, 11
 - bulb replacement, 11
 - factory preset speeds, 4
 - features of, 1
 - maintenance of, 9
 - operating instructions, 2
 - o-ring, replacement of, 10
- endodontics mode, 6
 - handpiece settings in, 6
 - settings defined, 7

F

- factory preset speeds, 4
- features of A-dec EA-51LT electric motor, 1

I

- installation
 - handpiece on motor, 3
 - motor on handpiece tubing, 3

M

- maintenance
 - disinfecting and sterilization, 9

O

- operating instructions, 2
- O-ring replacement
 - Motor, 10
 - Motor tubing terminal, 10

P

- programming
 - handpiece settings in
 - Endodontics Mode, 6
 - handpiece settings in
 - Standard Mode, 5
 - touchpad in standard mode, 4

S

- safety notes, 2
- speeds, factory presets, 4
- standard mode
 - handpiece settings, 5
 - usage in, 4
- sterilizing motor, 9

T

- touchpad
 - programming of
 - endodontics mode, 6
 - standard mode, 4

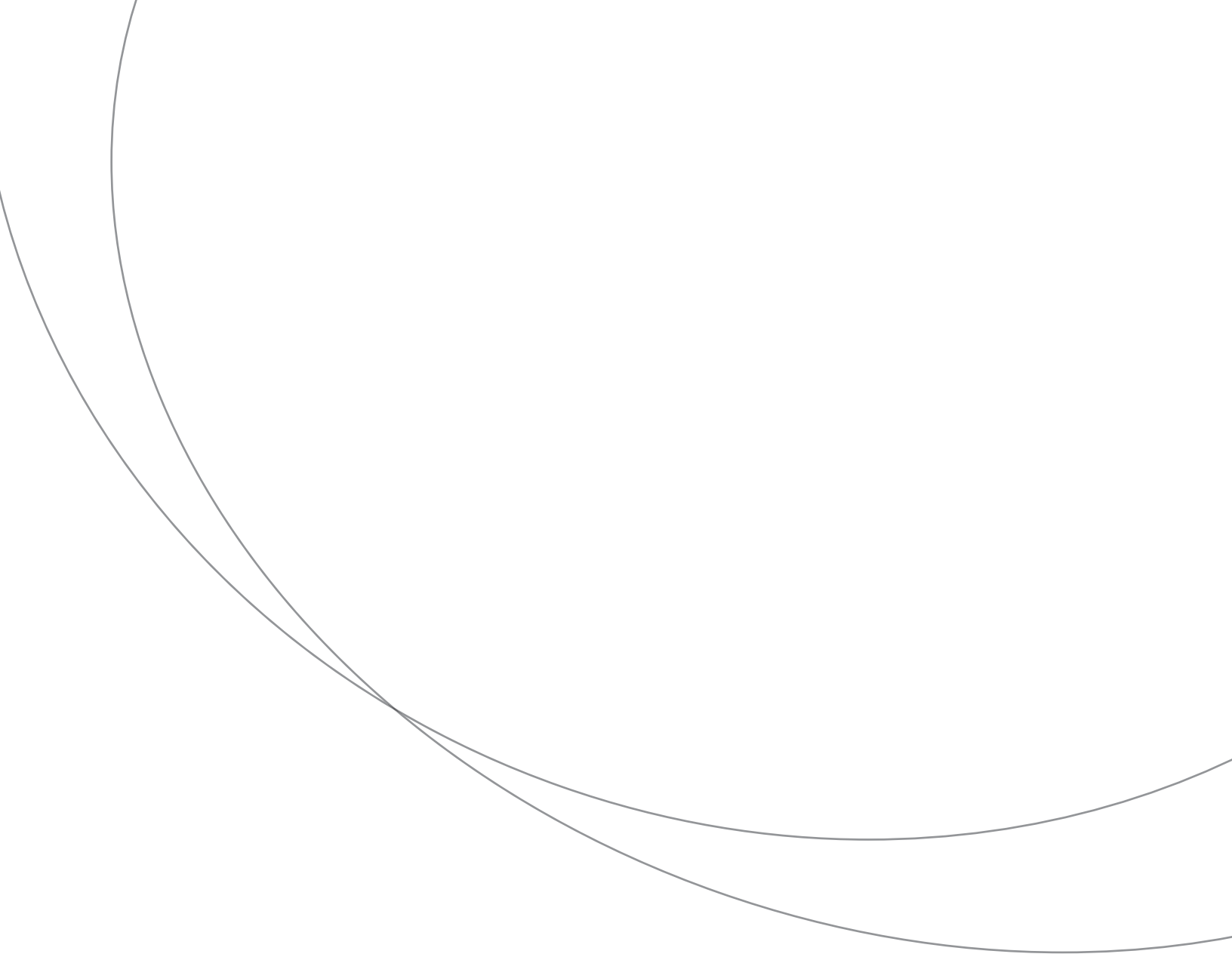

86.0616.00
Rev B 2007-12 (PCA 05995)
Copyright A-dec 2006
All rights reserved.

A-dec Inc.
2601 Crestview Drive
Newberg, OR 97132 USA
Tel: 1.800.547.1883
in U.S. & Canada
Tel: 1.503.538.7478
outside U.S. & Canada
www.a-dec.biz
www.a-dec.com

A-dec International Inc.
2601 Crestview Drive
Newberg, OR 97132 USA
Tel: 1.503.538.9471
www.a-dec.biz
www.a-dec.com

A-dec United Kingdom
Austin House, 11 Liberty Way
Nuneaton, Warwickshire CV11 6RZ
England
Tel: 0800 ADECUK (233285) within UK
Tel: 44 24 7635 0901 outside UK
www.a-dec.co.uk

A-dec Australia
41-43 Bowden Street
Alexandria NSW 2015
Australia
Tel: 61 (0)2 9699 4600
www.a-dec.com.au